

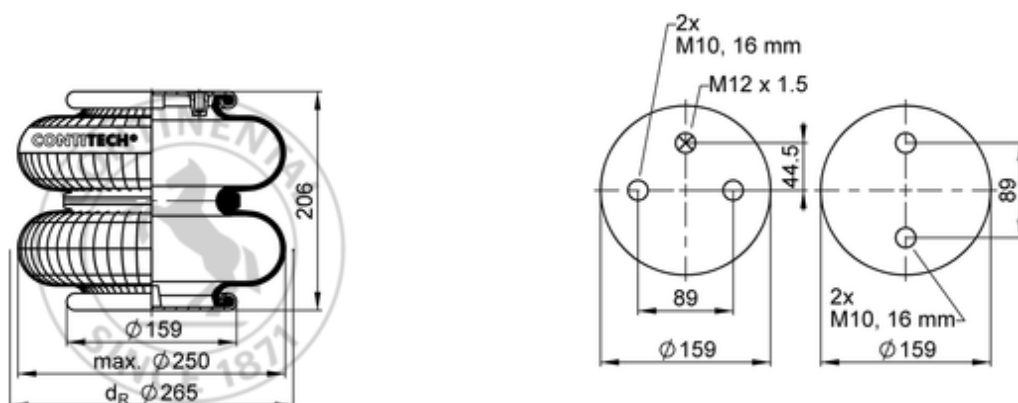









FD 200-19 P04

72044



 bolt or stud
  hole
  combination stud
  air inlet
  stud and nut

 kg	3 kg
	K023
	M10: max. 35 Nm
	M12x1.5: max. 40 Nm

OE Manufacturer/Reference No.

Manufacturer	Original-part no.	Model
Scania	1723523	
Kögel	6501706	
Granning	15599	
SAF - Holland	4.229.1004.00	1609
Scania	1319761	
Scania	1387289	