

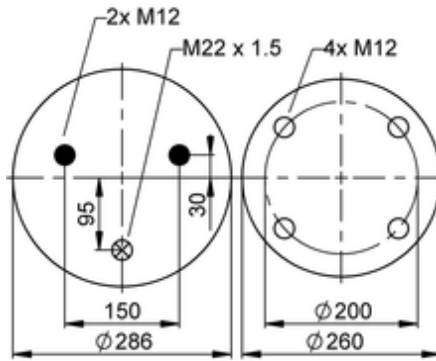

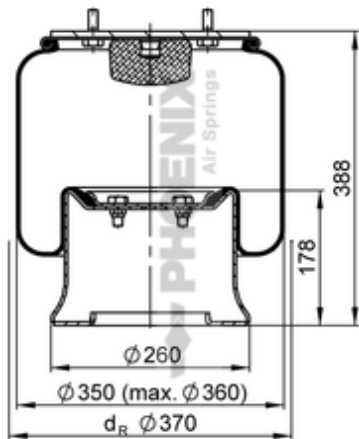



1 D 28 F-5

71744



● bolt or stud ○ hole ⊗ combination stud ⊗ air inlet

	15,8 kg
	K028
	
	M12: max. 70 Nm
	M22x1.5: max. 20 Nm

OE Manufacturer/Part No.

Manufacturer	Original Part No.	Model
Scania	2198324	
Weweler	YP4031N-F	
Schmitz	017 089	
Weweler	US 04029P	
Schmitz	017 685	
Weweler	US 04031P	

