

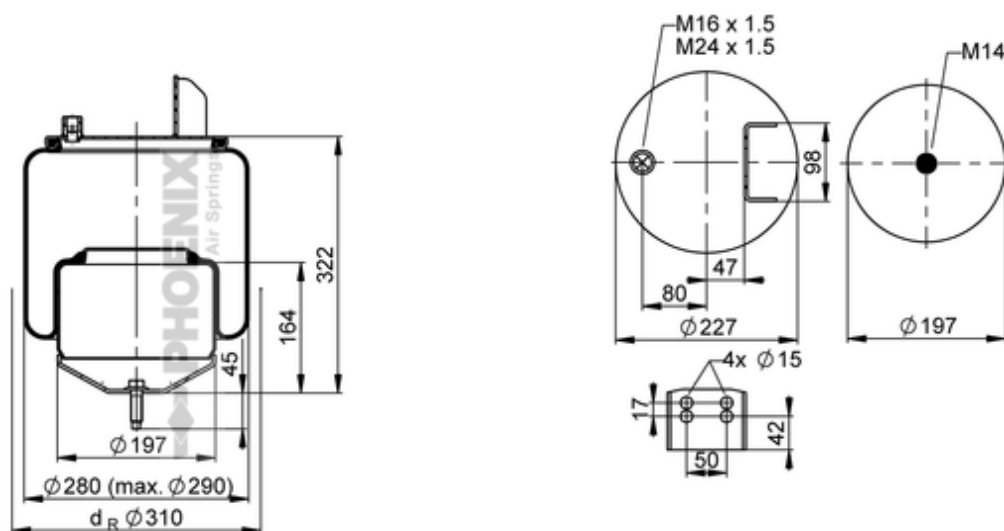





1 DF 20 D-1

72179



● bolt or stud      ○ hole      ⊗ combination stud      ⊗ air inlet

 kg	7 kg
	K005
	
	M14: max. 80 Nm
	M16x1.5: max. 20 Nm
	M24x1.5: max. 40 Nm

**OE Manufacturer/Part No.**

Manufacturer	Original Part No.	Model
Volvo	1 076 415	FH 12
Volvo	20 531 984	FH standard
Volvo	20 427 800	FH standard
Volvo	20 456 150	FH standard
Volvo	20 375 226	FH standard

Volvo	1 075 890	FH standard
Volvo	20 582 206	FM / FH standard
Volvo	21 961 374	FM / FH standard