

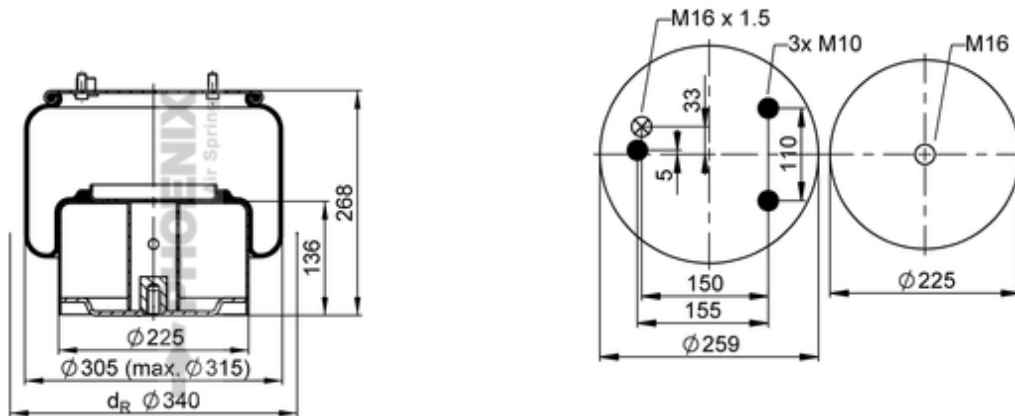





1 DF 25-11

71313



● bolt or stud      ○ hole      ⊗ combination stud      ⊗ air inlet

 kg	8,8 kg
	K008
	
	M10: max. 35 Nm
	M16: max. 130 Nm
	M16x1.5: max. 20 Nm

**OE Manufacturer/Part No.**

Manufacturer	Original Part No.	Model
DAF	0 388 165	
DAF	1 529 833	
DAF	1 697 678	CF 65
DAF	1 697 678	CF 75-85
DAF	1 697 678	LF 45-55

DAF

1 697 678

XF 95-105