

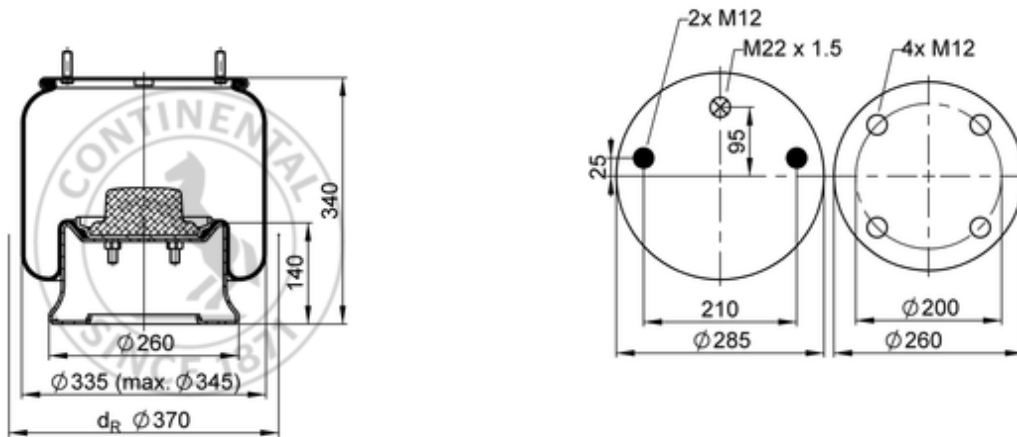









4810 N P05

61162



 bolt or stud
  hole
  combination stud
  air inlet
  stud and nut

 kg	12,3 kg
	K001
	
	M12: max. 70 Nm
	M22x1.5: max. 20 Nm

OE Manufacturer/Part No.

Manufacturer	Original Part No.	Model
SAF - Holland	2918V	
Scania	1723275	
SAF - Holland	3.229.0027.00	2918 V
SAF - Holland	3.229.2227.00	2918 V
SAF - Holland	3.229.2127.00	2918 V P01
SAF - Holland	3.228.0027.00	2918 V P03 Modul

